

Universal Type Cable Trays

Üniversal Tip Kablo Kanalları

	Order Code Sipariş Kodu	Width Genişlik (mm)	Thickness Kalınlık (mm)	Weight* Ağırlık (Kg/m)	Weight** Ağırlık (Kg/m)
100	EU-10040-060	100	0.60	0,826	0,989
200	EU-20040-060	200	0.60	1,251	1,498
300	EU-30040-080	300	0.80	2,207	2,533
400	EU-40040-080	400	0.80	2,774	3,184
500	EU-50040-100	500	1.00	4,133	4,621
600	EU-60040-100	600	1.00	4,841	5,413

Weight* This weight is unit weight of Pregalvanized products.
Ağırlık* Pregalvaniz ürünlerin birim ağırlığıdır.

Weight** This weight is unit weight of Hot-dip galvanization coated products.
Ağırlık** Sıcak Daldırma Galvaniz kaplamalı ürünlerin birim ağırlığıdır.

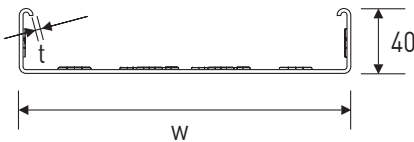
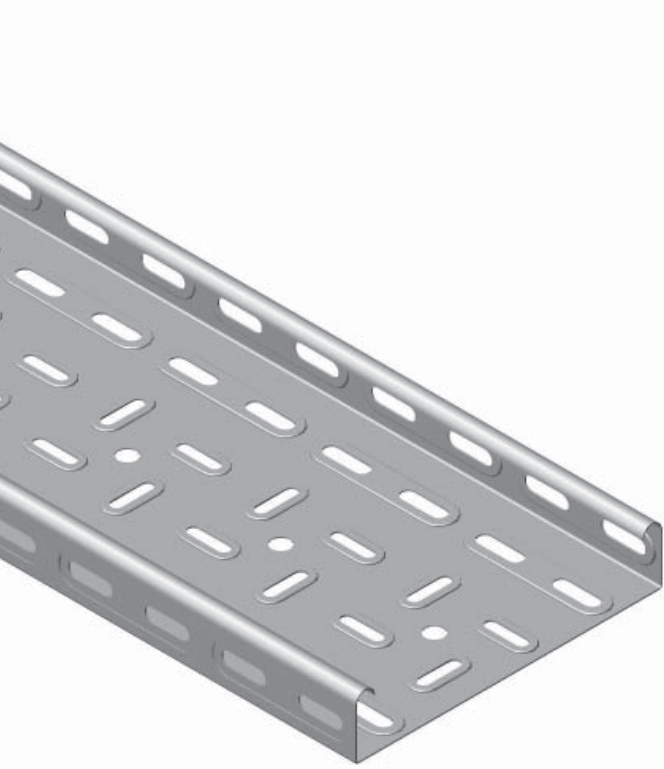

Description			
EU - 600	40	- 100	
Type	Width	Height	Thickness

Coating Type
P/HD/SP/E
Pregalvanized
Hot Dip Galvanized
Elektrostatic Paint
Elektro Galvanized

Length
2500/3000
mm

ETJ40 SERIES

Joint Pieces

Bağlantı Elemanları

Order Code
Sipariş Kodu

Height
Yükseklik
(mm)

Thickness
Kalınlık
(mm)

Weight*
Ağırlık
(Kg/Pcs)

Weight**
Ağırlık
(Kg/Pcs)

40

ETJ-40-150

40

1.50

0,106

0,115

ETJ-40-200

40

2.00

0,140

0,150

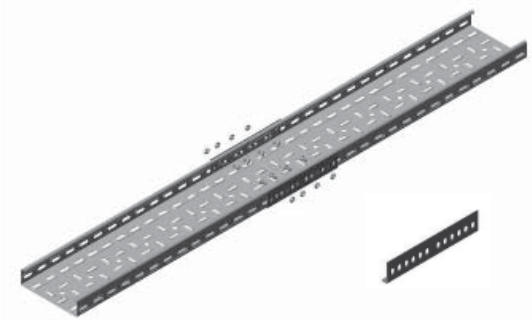

ETS40 SERIES

Separators

Ayırıcı Separatörler

Order Code
Sipariş Kodu

Height
Yükseklik
(mm)

Thickness
Kalınlık
(mm)

Weight*
Ağırlık
(Kg/m)

Weight**
Ağırlık
(Kg/m)

40

ETS-40-080

40

0.80

0.347

0.398

ETS-40-100

40

1.00

0.433

0.484



EU40 SERIES

Loading Diagram

Yükleme Diyagramı

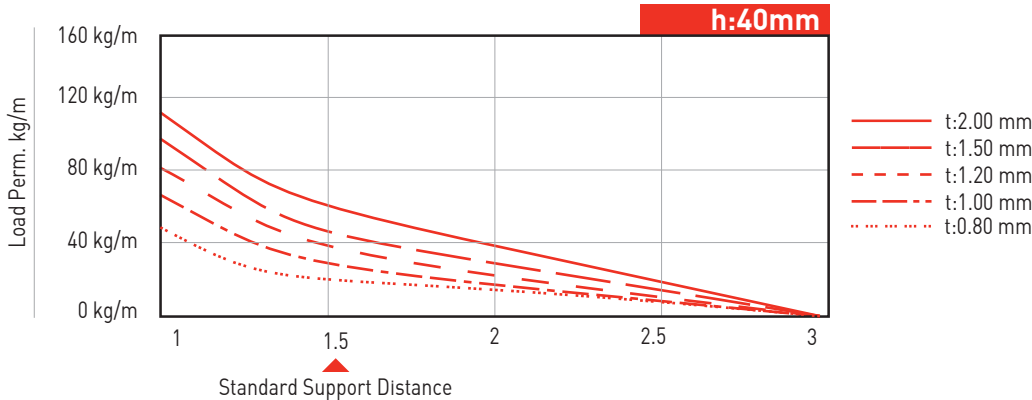



90° Horizontal Bends

90° Yatay Dönüş Elemanları (Standart)

	Order Code Sipariş Kodu	Width Genişlik (mm)	Thickness Kalınlık (mm)	Weight* Ağırlık (Kg/Pcs)	Weight** Ağırlık (Kg/Pcs)
	ET-10040-150HB	105	1.50	0,791	0,857
1.50	ET-20040-150HB	205	1.50	1,415	1,534
	ET-30040-200HB	305	2.00	2,751	2,957
	ET-40040-200HB	405	2.00	4,161	4,467
	ET-50040-200HB	505	2.00	5,886	6,313
2.00	ET-60040-200HB	605	2.00	7,924	8,494

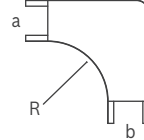
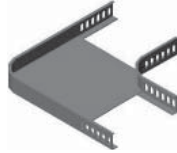

Please specify a, b dimensions in your private orders.
Özel siparişlerinizde a, b ölçülerini lütfen belirtiniz.



Horizontal Tees

T Bağlantı Elemanları (Standart)

	Order Code Sipariş Kodu	Width Genişlik (mm)	Thickness Kalınlık (mm)	Weight* Ağırlık (Kg/Pcs)	Weight** Ağırlık (Kg/Pcs)
	ET-10040-150HT	105	1.50	1,008	1,092
1.50	ET-20040-150HT	205	1.50	1,617	1,753
	ET-30040-200HT	305	2.00	3,005	3,228
	ET-40040-200HT	405	2.00	4,420	4,741
	ET-50040-200HT	505	2.00	6,149	6,590
2.00	ET-60040-200HT	605	2.00	8,192	8,774

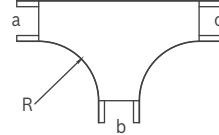
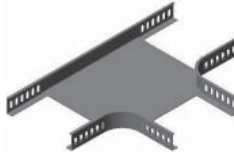

Please specify a, b, c dimensions in your private orders.
Özel siparişlerinizde a, b, c ölçülerini lütfen belirtiniz.



Adjustable Internal Risers

Ayarlanabilir İç Bükey Dönüş Elemanları

	Order Code Sipariş Kodu	Width Genişlik (mm)	Thickness Kalınlık (mm)	Weight* Ağırlık (Kg/Pcs)	Weight** Ağırlık (Kg/Pcs)
	EU-10040-060IR	100	0.60	0,774	0,927
0.60	EU-20040-060IR	200	0.60	1,199	1,435
	EU-30040-080IR	300	0.80	2,138	2,454
0.80	EU-40040-080IR	400	0.80	2,705	3,105
	EU-50040-100IR	500	1.00	4,045	4,523
1.00	EU-60040-100IR	600	1.00	4,753	5,315



HB40 SERIES



45° Horizontal Bends

45° Yatay Dönüş Elemanları (Standart)

	Order Code Sipariş Kodu	Width Genişlik (mm)	Thickness Kalınlık (mm)	Weight* Ağırlık (Kg/Pcs)	Weight** Ağırlık (Kg/Pcs)
	ET-10040-150HB45	105	1.50	0,527	0,571
1.50	ET-20040-150HB45	205	1.50	0,797	0,864
	ET-30040-200HB45	305	2.00	1,435	1,538
	ET-40040-200HB45	405	2.00	2,033	2,179
	ET-50040-200HB45	505	2.00	2,765	2,961
2.00	ET-60040-200HB45	605	2.00	3,627	3,882

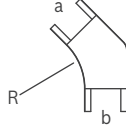

Please specify a, b dimensions in your private orders.
Özel siparişlerinizde a, b ölçülerini lütfen belirtiniz.

HC40 SERIES



Horizontal Cross

Dörtlü Bağlantı Elemanları (Standart)

	Order Code Sipariş Kodu	Width Genişlik (mm)	Thickness Kalınlık (mm)	Weight* Ağırlık (Kg/Pcs)	Weight** Ağırlık (Kg/Pcs)
	ET-10040-150HC	105	1.50	1,228	1,330
1.50	ET-20040-150HC	205	1.50	1,821	1,974
	ET-30040-200HC	305	2.00	3,271	3,511
	ET-40040-200HC	405	2.00	4,690	5,027
	ET-50040-200HC	505	2.00	6,423	6,879
2.00	ET-60040-200HC	605	2.00	8,470	9,066

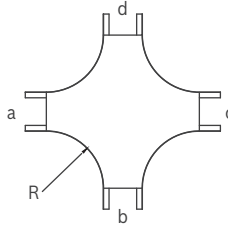

Please specify a, b, c, d dimensions in your private orders.
Özel siparişlerinizde a, b, c, d ölçülerini lütfen belirtiniz.

ER40 SERIES



Adjustable External Risers

Ayarlanabilir Dış Bükey Dönüş Elemanları

	Order Code Sipariş Kodu	Width Genişlik (mm)	Thickness Kalınlık (mm)	Weight* Ağırlık (Kg/Pcs)	Weight** Ağırlık (Kg/Pcs)
	EU-10040-060ER	100	0.60	0,798	0,955
0.60	EU-20040-060ER	200	0.60	1,223	1,464
	EU-30040-080ER	300	0.80	2,170	2,491
0.80	EU-40040-080ER	400	0.80	2,737	3,141
	EU-50040-100ER	500	1.00	4,087	4,570
1.00	EU-60040-100ER	600	1.00	4,795	5,362



RC40 SERIES

Reducers (Center)

Redüksiyonlar (Merkez)

	Order Code Sipariş Kodu	Width Genişlik (mm)	Thickness Kalınlık (mm)	Weight* Ağırlık (Kg/Pcs)	Weight** Ağırlık (Kg/Pcs)
1.50	ET-20040-150RC	205	1.50	1,046	1,134
	ET-30040-200RC	305	2.00	2,102	2,262
	ET-40040-200RC	405	2.00	3,266	3,508
	ET-50040-200RC	505	2.00	4,791	5,140
2.00	ET-60040-200RC	605	2.00	6,632	7,110

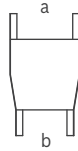
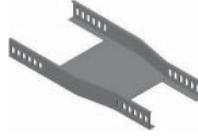

Please specify a, b dimensions in your private orders.
Özel siparişlerinizde a, b ölçülerini lütfen belirtiniz.

RR40 SERIES

Reducers (Right)

Redüksiyonlar (Sağ)

	Order Code Sipariş Kodu	Width Genişlik (mm)	Thickness Kalınlık (mm)	Weight* Ağırlık (Kg/Pcs)	Weight** Ağırlık (Kg/Pcs)
1.50	ET-20040-150RR	205	1.50	1,034	1,121
	ET-30040-200RR	305	2.00	2,102	2,262
	ET-40040-200RR	405	2.00	3,271	3,513
	ET-50040-200RR	505	2.00	4,495	5,144
2.00	ET-60040-200RR	605	2.00	6,635	7,114

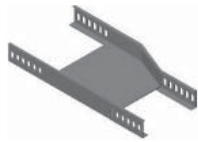

Please specify a, b dimensions in your private orders.
Özel siparişlerinizde a, b ölçülerini lütfen belirtiniz.

RL40 SERIES

Reducers (Left)

Redüksiyonlar (Sol)

	Order Code Sipariş Kodu	Width Genişlik (mm)	Thickness Kalınlık (mm)	Weight* Ağırlık (Kg/Pcs)	Weight** Ağırlık (Kg/Pcs)
1.50	ET-20040-150RL	205	1.50	1,034	1,121
	ET-30040-200RL	305	2.00	2,102	2,262
	ET-40040-200RL	405	2.00	3,271	3,513
	ET-50040-200RL	505	2.00	4,795	5,144
2.00	ET-60040-200RL	605	2.00	6,635	7,114

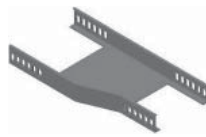

Please specify a, b dimensions in your private orders.
Özel siparişlerinizde a, b ölçülerini lütfen belirtiniz.

RJ40 SERIES

Reducing Plate

Ek Parça Tipi Redüksiyon Elemanları

	Order Code Sipariş Kodu	Width Genişlik (mm)	Thickness Kalınlık (mm)	Weight* Ağırlık (Kg/Pcs)	Weight** Ağırlık (Kg/Pcs)
	ET-05040-200RJ	50	2.00	0,137	0,146
	ET-10040-200RJ	100	2.00	0,168	0,180
	ET-15040-200RJ	150	2.00	0,200	0,213
	ET-20040-200RJ	200	2.00	0,231	0,247
	ET-25040-200RJ	250	2.00	0,262	0,280
	ET-30040-200RJ	300	2.00	0,294	0,314
	ET-40040-200RJ	400	2.00	0,357	0,381
40	ET-50040-200RJ	500	2.00	0,719	0,448

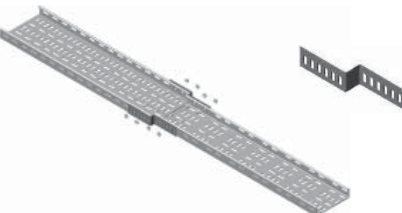

VT40 SERIES



Vertical Tees

Dikey T Bağlantı Elemanları



	Order Code Sipariş Kodu	Width Genişlik (mm)	Thickness Kalınlık (mm)	Weight* Ağırlık (Kg/Pcs)	Weight** Ağırlık (Kg/Pcs)
1.50	ET-10040-150VT	105	1.50	1,438	1,560
	ET-20040-150VT	205	1.50	3,267	3,545
	ET-30040-200VT	305	2.00	7,523	8,036
2.00	ET-40040-200VT	405	2.00	11,895	12,707
	ET-50040-200VT	505	2.00	17,119	18,286
	ET-60040-200VT	605	2.00	22,688	24,236

LC40 SERIES

Level Changing Parts

Seviye Değişirme Elemanları

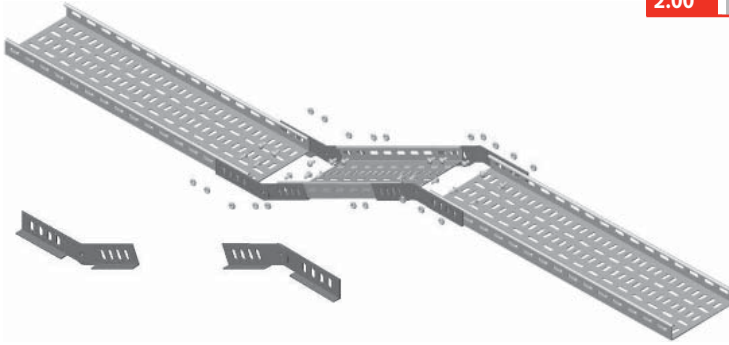

	Order Code Sipariş Kodu	Height Yükseklik (mm)	Thickness Kalınlık (mm)	Weight* Ağırlık (Kg/Set)	Weight** Ağırlık (Kg/Set)
2.00	ETLC-40-200	40	2.00	0,308	0,329

DC40 SERIES

Direction Changing Parts

Yön Değişirme Elemanları



	Order Code Sipariş Kodu	Height Yükseklik (mm)	Thickness Kalınlık (mm)	Weight* Ağırlık (Kg/Pcs)	Weight** Ağırlık (Kg/Pcs)
2.00	ETDC-40-200	40	2.00	0,140	0,150

EP40 SERIES

End Parts

Sonlandırma Elemanları

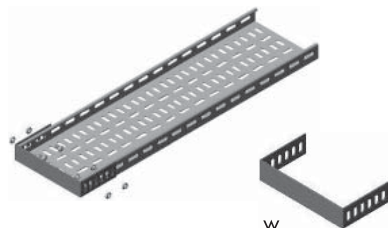

	Order Code Sipariş Kodu	Width Genişlik (mm)	Thickness Kalınlık (mm)	Weight* Ağırlık (Kg/Pcs)	Weight** Ağırlık (Kg/Pcs)
1.50	ET-10040-150EP	105	1.50	0,128	0,139
	ET-20040-150EP	205	1.50	0,175	0,190
	ET-30040-200EP	305	2.00	0,296	0,317
2.00	ET-40040-200EP	405	2.00	0,359	0,384
	ET-50040-200EP	505	2.00	0,422	0,451
	ET-60040-200EP	605	2.00	0,485	0,518

Universal Type Cable Trays

Üniversal Tip Kablo Kanalları

	Order Code Sipariş Kodu	Width Genişlik (mm)	Thickness Kalınlık (mm)	Weight* Ağırlık (Kg/m)	Weight** Ağırlık (Kg/m)
100	EU-10050-060	100	0.60	0,920	1,102
200	EU-20050-060	200	0.60	1,345	1,610
300	EU-30050-080	300	0.80	2,332	2,677
400	EU-40050-080	400	0.80	2,899	3,328
500	EU-50050-100	500	1.00	4,290	4,797
600	EU-60050-100	600	1.00	4,998	5,589

Weight* This weight is unit weight of Pregalvanized products.
Ağırlık* Pregalvaniz ürünlerin birim ağırlığıdır.

Weight** This weight is unit weight of Hot-dip galvanization coated products.
Ağırlık** Sıcak Daldırma Galvaniz kaplamalı ürünlerin birim ağırlığıdır.

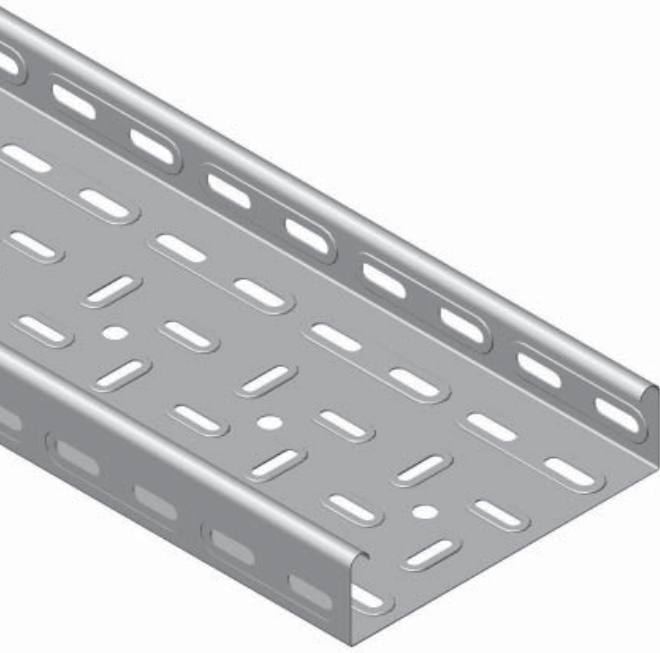

Description			
EU - 600	50	- 100	
Type	Width	Height	Thickness

Coating Type
P/HD/SP/E
Pregalvanized
Hot Dip Galvanized
Elektrostatic Paint
Elektro Galvanized

Length
2500/3000
mm

ETJ50 SERIES

Joint Pieces

Bağlantı Elemanları

Order Code
Sipariş Kodu

Height
Yükseklik
(mm)

Thickness
Kalınlık
(mm)

Weight*
Ağırlık
(Kg/Pcs)

Weight**
Ağırlık
(Kg/Pcs)

50

ETJ-50-150

50

1.50

0,129

0,140

ETJ-50-200

50

2.00

0,172

0,184

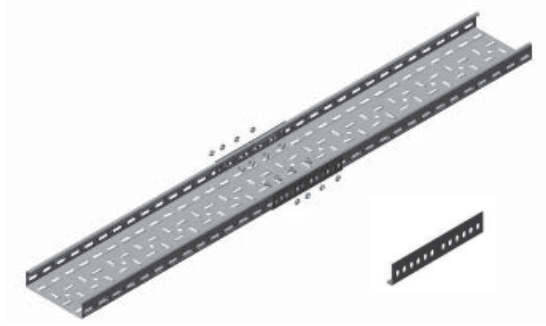

ETS50 SERIES

Separators

Ayırıcı Separatörler

Order Code
Sipariş Kodu

Height
Yükseklik
(mm)

Thickness
Kalınlık
(mm)

Weight*
Ağırlık
(Kg/m)

Weight**
Ağırlık
(Kg/m)

50

ETS-50-080

50

0.80

0,410

0,470

ETS-50-100

50

1.00

0,512

0,572



EU50 SERIES

Loading Diagram

Yükleme Diyagramı

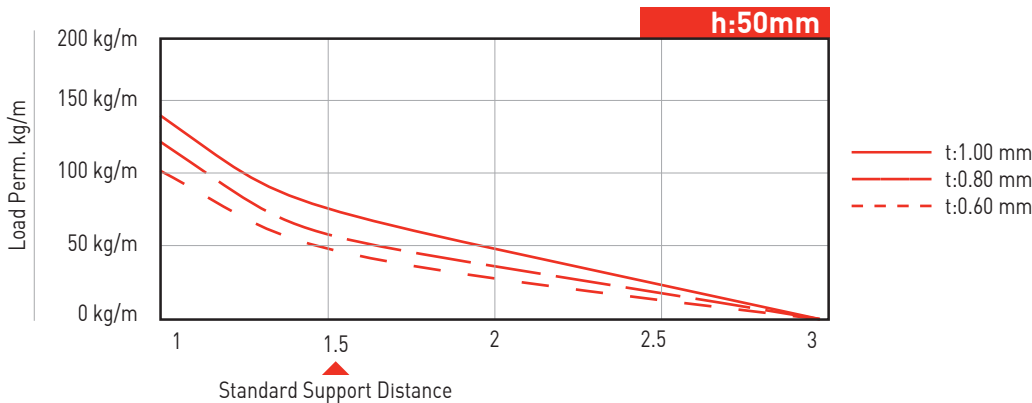



90° Horizontal Bends

90° Yatay Dönüş Elemanları (Standart)

	Order Code Sipariş Kodu	Width Genişlik (mm)	Thickness Kalınlık (mm)	Weight* Ağırlık (Kg/Pcs)	Weight** Ağırlık (Kg/Pcs)
	ET-10050-150HB	105	1.50	0,884	0,958
1.50	ET-20050-150HB	205	1.50	1,532	1,661
	ET-30050-200HB	305	2.00	2,891	3,110
	ET-40050-200HB	405	2.00	4,326	4,646
	ET-50050-200HB	505	2.00	6,074	6,518
2.00	ET-60050-200HB	605	2.00	8,136	8,724

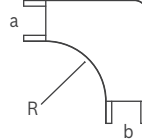
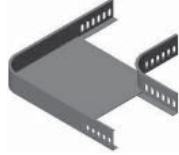

Please specify a, b dimensions in your private orders.
Özel siparişlerinizde a, b ölçülerini lütfen belirtiniz.



Horizontal Tees

T Bağlantı Elemanları (Standart)

	Order Code Sipariş Kodu	Width Genişlik (mm)	Thickness Kalınlık (mm)	Weight* Ağırlık (Kg/Pcs)	Weight** Ağırlık (Kg/Pcs)
	ET-10050-150HT	105	1.50	1,127	1,221
1.50	ET-20050-150HT	205	1.50	1,748	1,894
	ET-30050-200HT	305	2.00	3,147	3,383
	ET-40050-200HT	405	2.00	4,574	4,909
	ET-50050-200HT	505	2.00	6,315	6,771
2.00	ET-60050-200HT	605	2.00	8,370	8,968

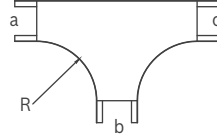

Please specify a, b, c dimensions in your private orders.
Özel siparişlerinizde a, b, c ölçülerini lütfen belirtiniz.



Adjustable Internal Risers

Ayarlanabilir İç Bükey Dönüş Elemanları

	Order Code Sipariş Kodu	Width Genişlik (mm)	Thickness Kalınlık (mm)	Weight* Ağırlık (Kg/Pcs)	Weight** Ağırlık (Kg/Pcs)
	EU-10050-060IR	100	0.60	0,853	1,021
0.60	EU-20050-060IR	200	0.60	1,278	1,530
	EU-30050-080IR	300	0.80	2,243	2,575
0.80	EU-40050-080IR	400	0.80	2,810	3,226
	EU-50050-100IR	500	1.00	4,177	4,671
1.00	EU-60050-100IR	600	1.00	4,885	5,462



HB50 SERIES



45° Horizontal Bends

45° Yatay Dönüş Elemanları (Standart)

	Order Code Sipariş Kodu	Width Genişlik (mm)	Thickness Kalınlık (mm)	Weight* Ağırlık (Kg/Pcs)	Weight** Ağırlık (Kg/Pcs)
	ET-10050-150HB45	105	1.50	0,600	0,649
1.50	ET-20050-150HB45	205	1.50	0,879	0,953
	ET-30050-200HB45	305	2.00	1,537	1,649
	ET-40050-200HB45	405	2.00	2,146	2,300
	ET-50050-200HB45	505	2.00	2,887	3,092
2.00	ET-60050-200HB45	605	2.00	3,759	4,024

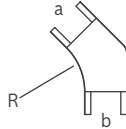

Please specify a, b dimensions in your private orders.
Özel siparişlerinizde a, b ölçülerini lütfen belirtiniz.

HC50 SERIES



Horizontal Cross

Dörtlü Bağlantı Elemanları (Standart)

	Order Code Sipariş Kodu	Width Genişlik (mm)	Thickness Kalınlık (mm)	Weight* Ağırlık (Kg/Pcs)	Weight** Ağırlık (Kg/Pcs)
	ET-10050-150HC	105	1.50	1,367	1,480
1.50	ET-20050-150HC	205	1.50	1,960	2,124
	ET-30050-200HC	305	2.00	3,409	3,662
	ET-40050-200HC	405	2.00	4,829	5,178
	ET-50050-200HC	505	2.00	6,562	7,030
2.00	ET-60050-200HC	605	2.00	8,609	9,217

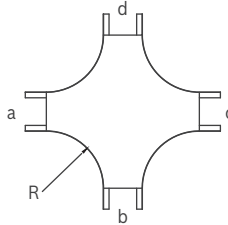

Please specify a, b, c, d dimensions in your private orders.
Özel siparişlerinizde a, b, c, d ölçülerini lütfen belirtiniz.

ER50 SERIES



Adjustable External Risers

Ayarlanabilir Dış Bükey Dönüş Elemanları

	Order Code Sipariş Kodu	Width Genişlik (mm)	Thickness Kalınlık (mm)	Weight* Ağırlık (Kg/Pcs)	Weight** Ağırlık (Kg/Pcs)
	EU-10050-060ER	100	0.60	0,884	1,059
0.60	EU-20050-060ER	200	0.60	1,309	1,567
	EU-30050-080ER	300	0.80	2,284	2,622
0.80	EU-40050-080ER	400	0.80	2,851	3,273
	EU-50050-100ER	500	1.00	4,230	4,730
1.00	EU-60050-100ER	600	1.00	4,938	5,521



RC50 SERIES



Reducers (Center)

Redüksiyonlar (Merkez)

	Order Code Sipariş Kodu	Width Genişlik (mm)	Thickness Kalınlık (mm)	Weight* Ağırlık (Kg/Pcs)	Weight** Ağırlık (Kg/Pcs)
1.50	ET-20050-150RC	205	1.50	1,147	1,243
	ET-30050-200RC	305	2.00	2,226	2,396
	ET-40050-200RC	405	2.00	3,414	3,669
	ET-50050-200RC	505	2.00	4,962	5,327
2.00	ET-60050-200RC	605	2.00	6,827	7,322

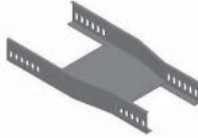

Please specify a, b dimensions in your private orders.
Özel siparişlerinizde a, b ölçülerini lütfen belirtiniz.

RR50 SERIES



Reducers (Right)

Redüksiyonlar (Sağ)

	Order Code Sipariş Kodu	Width Genişlik (mm)	Thickness Kalınlık (mm)	Weight* Ağırlık (Kg/Pcs)	Weight** Ağırlık (Kg/Pcs)
1.50	ET-20050-150RR	205	1.50	1,134	1,229
	ET-30050-200RR	305	2.00	2,226	2,396
	ET-40050-200RR	405	2.00	3,420	3,676
	ET-50050-200RR	505	2.00	4,967	5,332
2.00	ET-60050-200RR	605	2.00	6,831	7,327

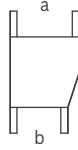
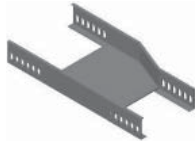

Please specify a, b dimensions in your private orders.
Özel siparişlerinizde a, b ölçülerini lütfen belirtiniz.

RL50 SERIES



Reducers (Left)

Redüksiyonlar (Sol)

	Order Code Sipariş Kodu	Width Genişlik (mm)	Thickness Kalınlık (mm)	Weight* Ağırlık (Kg/Pcs)	Weight** Ağırlık (Kg/Pcs)
1.50	ET-20050-150RL	205	1.50	1,134	1,229
	ET-30050-200RL	305	2.00	2,226	2,396
	ET-40050-200RL	405	2.00	3,420	3,676
	ET-50050-200RL	505	2.00	4,967	5,332
2.00	ET-60050-200RL	605	2.00	6,831	7,327

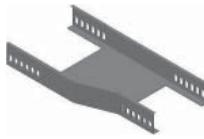

Please specify a, b dimensions in your private orders.
Özel siparişlerinizde a, b ölçülerini lütfen belirtiniz.

RJ50 SERIES

Reducing Plate

Ek Parça Tipi Redüksiyon Elemanları

	Order Code Sipariş Kodu	Width Genişlik (mm)	Thickness Kalınlık (mm)	Weight* Ağırlık (Kg/Pcs)	Weight** Ağırlık (Kg/Pcs)
	ET-05050-200RJ	50	2.00	0,178	0,190
	ET-10050-200RJ	100	2.00	0,217	0,232
	ET-15050-200RJ	150	2.00	0,257	0,274
	ET-20050-200RJ	200	2.00	0,296	0,316
	ET-25050-200RJ	250	2.00	0,335	0,358
	ET-30050-200RJ	300	2.00	0,374	0,400
	ET-40050-200RJ	400	2.00	0,453	0,484
50	ET-50050-200RJ	500	2.00	0,531	0,568

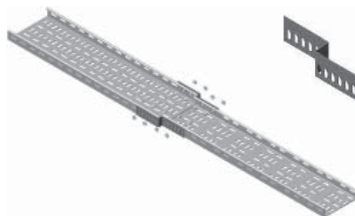

Universal Type Cable Trays

GENERAL CATALOGUE 2010

VT50 SERIES



Vertical Tees

Dikey T Bağlantı Elemanları



	Order Code Sipariş Kodu	Width Genişlik (mm)	Thickness Kalınlık (mm)	Weight* Ağırlık (Kg/Pcs)	Weight** Ağırlık (Kg/Pcs)
	ET-10050-150VT	105	1.50	1,498	1,625
1.50	ET-20050-150VT	205	1.50	3,361	3,646
	ET-30050-200VT	305	2.00	7,692	8,217
	ET-40050-200VT	405	2.00	12,109	12,935
	ET-50050-200VT	505	2.00	17,377	18,562
2.00	ET-60050-200VT	605	2.00	22,991	24,559

LC50 SERIES

Level Changing Parts

Seviye Değişirme Elemanları

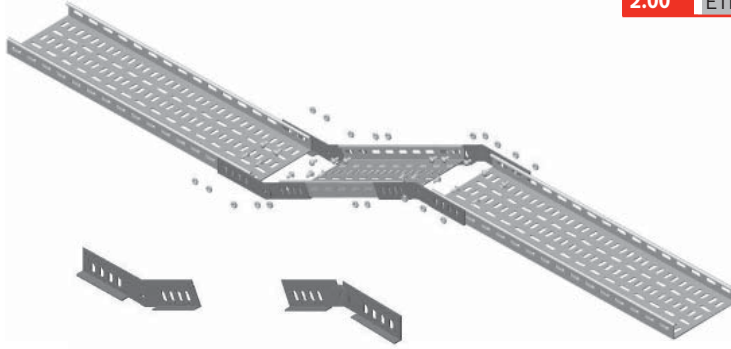

	Order Code Sipariş Kodu	Height Yükseklik (mm)	Thickness Kalınlık (mm)	Weight* Ağırlık (Kg/Set)	Weight** Ağırlık (Kg/Set)
2.00	ETLC-50-200	50	2.00	0,357	0,381

DC50 SERIES

Direction Changing Parts

Yön Değişirme Elemanları

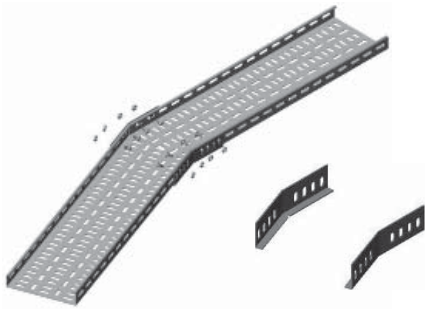

	Order Code Sipariş Kodu	Height Yükseklik (mm)	Thickness Kalınlık (mm)	Weight* Ağırlık (Kg/Pcs)	Weight** Ağırlık (Kg/Pcs)
2.00	ETDC-50-200	50	2.00	0,172	0,184

EP50 SERIES

End Parts

Sonlandırma Elemanları

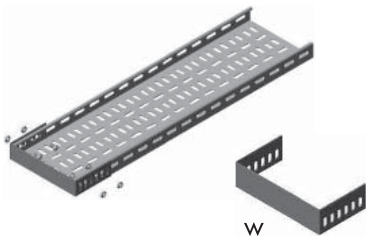

	Order Code Sipariş Kodu	Width Genişlik (mm)	Thickness Kalınlık (mm)	Weight* Ağırlık (Kg/Pcs)	Weight** Ağırlık (Kg/Pcs)
	ET-10050-150EP	105	1.50	0,165	0,179
1.50	ET-20050-150EP	205	1.50	0,224	0,243
	ET-30050-200EP	305	2.00	0,378	0,403
	ET-40050-200EP	405	2.00	0,456	0,487
	ET-50050-200EP	505	2.00	0,535	0,571
2.00	ET-60050-200EP	605	2.00	0,613	0,655

Universal Type Cable Trays

Üniversal Tip Kablo Kanalları

	Order Code Sipariş Kodu	Width Genişlik (mm)	Thickness Kalınlık (mm)	Weight* Ağırlık (Kg/m)	Weight** Ağırlık (Kg/m)
100	EU-10060-060	100	0.60	1,015	1,214
200	EU-20060-060	200	0.60	1,440	1,723
300	EU-30060-080	300	0.80	2,458	2,821
400	EU-40060-080	400	0.80	3,025	3,472
500	EU-50060-100	500	1.00	4,447	4,972
600	EU-60060-100	600	1.00	5,155	5,764

Weight* This weight is unit weight of Pregalvanized products.
Ağırlık* Pregalvaniz ürünlerin birim ağırlığıdır.

Weight** This weight is unit weight of Hot-dip galvanization coated products.
Ağırlık** Sıcak Daldırma Galvaniz kaplamalı ürünlerin birim ağırlığıdır.

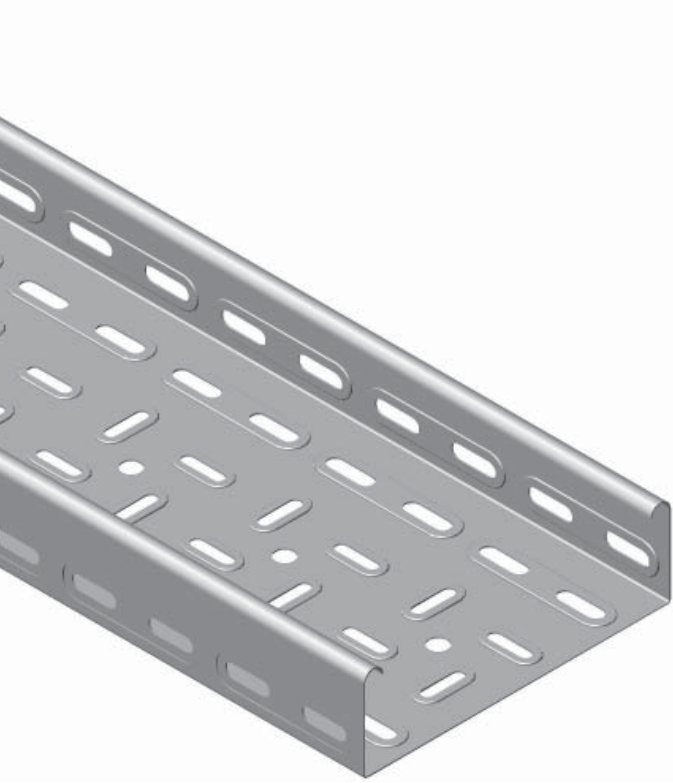

Description			
EU - 600	60	60	- 100
Type	Width	Height	Thickness

Coating Type
P/HD/SP/E
Pregalvanized
Hot Dip Galvanized
Elektrostatic Paint
Elektro Galvanized

Length
2500/3000
mm

ETJ60 SERIES

Joint Pieces

Bağlantı Elemanları

Order Code
Sipariş Kodu

Height
Yükseklik
(mm)

Thickness
Kalınlık
(mm)

Weight*
Ağırlık
(Kg/Pcs)

Weight**
Ağırlık
(Kg/Pcs)

	ETJ-60-150	60	1.50	0,153	0,166
60	ETJ-60-200	60	2.00	0,203	0,217

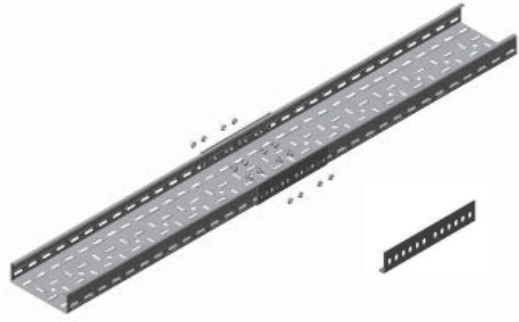

ETS60 SERIES

Separators

Ayırıcı Separatörler

Order Code
Sipariş Kodu

Height
Yükseklik
(mm)

Thickness
Kalınlık
(mm)

Weight*
Ağırlık
(Kg/m)

Weight**
Ağırlık
(Kg/m)

	ETS-60-080	60	0.80	0,472	0,542
60	ETS-60-100	60	1.00	0,590	0,660



EU60 SERIES

Loading Diagram

Yükleme Diyagramı

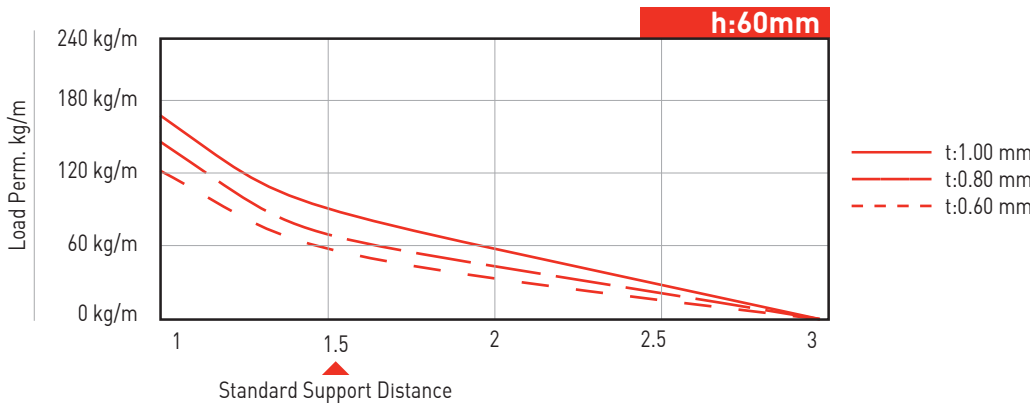



90° Horizontal Bends

90° Yatay Dönüş Elemanları (Standart)

	Order Code Sipariş Kodu	Width Genişlik (mm)	Thickness Kalınlık (mm)	Weight* Ağırlık (Kg/Pcs)	Weight** Ağırlık (Kg/Pcs)
	ET-10060-150HB	105	1.50	1,283	1,391
1.50	ET-20060-150HB	205	1.50	1,649	1,788
	ET-30060-200HB	305	2.00	3,032	3,263
	ET-40060-200HB	405	2.00	4,490	4,825
	ET-50060-200HB	505	2.00	6,262	6,722
2.00	ET-60060-200HB	605	2.00	8,347	8,955

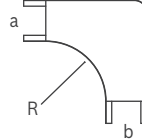
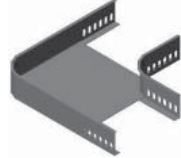

Please specify a, b dimensions in your private orders.
Özel siparişlerinizde a, b ölçülerini lütfen belirtiniz.



Horizontal Tees

T Bağlantı Elemanları (Standart)

	Order Code Sipariş Kodu	Width Genişlik (mm)	Thickness Kalınlık (mm)	Weight* Ağırlık (Kg/Pcs)	Weight** Ağırlık (Kg/Pcs)
	ET-10060-150HT	105	1.50	1,247	1,350
1.50	ET-20060-150HT	205	1.50	1,879	2,036
	ET-30060-200HT	305	2.00	3,290	3,538
	ET-40060-200HT	405	2.00	4,729	5,078
	ET-50060-200HT	505	2.00	6,481	6,952
2.00	ET-60060-200HT	605	2.00	8,548	9,162

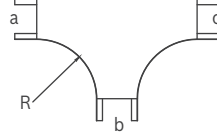

Please specify a, b, c dimensions in your private orders.
Özel siparişlerinizde a, b, c ölçülerini lütfen belirtiniz.



Adjustable Internal Risers

Ayarlanabilir İç Bükey Dönüş Elemanları

	Order Code Sipariş Kodu	Width Genişlik (mm)	Thickness Kalınlık (mm)	Weight* Ağırlık (Kg/Pcs)	Weight** Ağırlık (Kg/Pcs)
	EU-10060-060IR	100	0.60	0,932	1,115
0.60	EU-20060-060IR	200	0.60	1,357	1,624
	EU-30060-080IR	300	0.80	2,347	2,694
0.80	EU-40060-080IR	400	0.80	2,914	3,345
	EU-50060-100IR	500	1.00	4,307	4,816
1.00	EU-60060-100IR	600	1.00	5,014	5,606



HB60 SERIES



45° Horizontal Bends

45° Yatay Dönüş Elemanları (Standart)

	Order Code Sipariş Kodu	Width Genişlik (mm)	Thickness Kalınlık (mm)	Weight* Ağırlık (Kg/Pcs)	Weight** Ağırlık (Kg/Pcs)
	ET-10060-150HB45	105	1.50	0,800	0,866
1.50	ET-20060-150HB45	205	1.50	0,962	1,042
	ET-30060-200HB45	305	2.00	1,640	1,760
	ET-40060-200HB45	405	2.00	2,258	2,421
	ET-50060-200HB45	505	2.00	3,009	3,224
2.00	ET-60060-200HB45	605	2.00	3,891	4,167

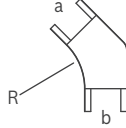

Please specify a, b dimensions in your private orders.
Özel siparişlerinizde a, b ölçülerini lütfen belirtiniz.

HC60 SERIES



Horizontal Cross

Dörtlü Bağlantı Elemanları (Standart)

	Order Code Sipariş Kodu	Width Genişlik (mm)	Thickness Kalınlık (mm)	Weight* Ağırlık (Kg/Pcs)	Weight** Ağırlık (Kg/Pcs)
	ET-10060-150HC	105	1.50	1,506	1,631
1.50	ET-20060-150HC	205	1.50	2,099	2,274
	ET-30060-200HC	305	2.00	3,548	3,813
	ET-40060-200HC	405	2.00	4,968	5,329
	ET-50060-200HC	505	2.00	6,701	7,181
2.00	ET-60060-200HC	605	2.00	8,748	9,368

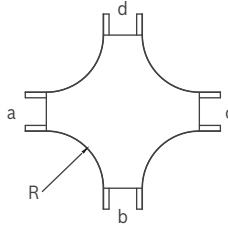

Please specify a, b, c, d dimensions in your private orders.
Özel siparişlerinizde a, b, c, d ölçülerini lütfen belirtiniz.

ER60 SERIES



Adjustable External Risers

Ayarlanabilir Dış Bükey Dönüş Elemanları

	Order Code Sipariş Kodu	Width Genişlik (mm)	Thickness Kalınlık (mm)	Weight* Ağırlık (Kg/Pcs)	Weight** Ağırlık (Kg/Pcs)
	EU-10060-060ER	100	0.60	0,970	1,161
0.60	EU-20060-060ER	200	0.60	1,395	1,669
	EU-30060-080ER	300	0.80	2,398	2,752
0.80	EU-40060-080ER	400	0.80	2,965	3,403
	EU-50060-100ER	500	1.00	4,372	4,889
1.00	EU-60060-100ER	600	1.00	5,080	5,680



RC60 SERIES



Reducers (Center)

Redüksiyonlar (Merkez)

	Order Code Sipariş Kodu	Width Genişlik (mm)	Thickness Kalınlık (mm)	Weight* Ağırlık (Kg/Pcs)	Weight** Ağırlık (Kg/Pcs)
1.50	ET-20060-150RC	205	1.50	1,248	1,352
	ET-30060-200RC	305	2.00	2,349	2,530
	ET-40060-200RC	405	2.00	3,562	3,830
	ET-50060-200RC	505	2.00	5,133	5,513
2.00	ET-60060-200RC	605	2.00	7,021	7,534

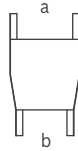
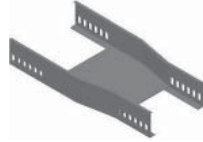

Please specify a, b dimensions in your private orders.
Özel siparişlerinizde a, b ölçülerini lütfen belirtiniz.

RR60 SERIES



Reducers (Right)

Redüksiyonlar (Sağ)

	Order Code Sipariş Kodu	Width Genişlik (mm)	Thickness Kalınlık (mm)	Weight* Ağırlık (Kg/Pcs)	Weight** Ağırlık (Kg/Pcs)
1.50	ET-20060-150RR	205	1.50	1,233	1,336
	ET-30060-200RR	305	2.00	2,350	2,531
	ET-40060-200RR	405	2.00	3,569	3,838
	ET-50060-200RR	505	2.00	5,139	5,520
2.00	ET-60060-200RR	605	2.00	7,026	7,539

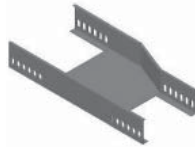

Please specify a, b dimensions in your private orders.
Özel siparişlerinizde a, b ölçülerini lütfen belirtiniz.

RL60 SERIES



Reducers (Left)

Redüksiyonlar (Sol)

	Order Code Sipariş Kodu	Width Genişlik (mm)	Thickness Kalınlık (mm)	Weight* Ağırlık (Kg/Pcs)	Weight** Ağırlık (Kg/Pcs)
1.50	ET-20060-150RL	205	1.50	1,233	1,336
	ET-30060-200RL	305	2.00	2,350	2,531
	ET-40060-200RL	405	2.00	3,569	3,838
	ET-50060-200RL	505	2.00	5,139	5,520
2.00	ET-60060-200RL	605	2.00	7,026	7,539

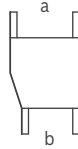

Please specify a, b dimensions in your private orders.
Özel siparişlerinizde a, b ölçülerini lütfen belirtiniz.

RJ60 SERIES

Reducing Plate

Ek Parça Tipi Redüksiyon Elemanları

	Order Code Sipariş Kodu	Width Genişlik (mm)	Thickness Kalınlık (mm)	Weight* Ağırlık (Kg/Pcs)	Weight** Ağırlık (Kg/Pcs)
	ET-05060-200RJ	50	2.00	0,191	0,204
	ET-10060-200RJ	100	2.00	0,238	0,254
	ET-15060-200RJ	150	2.00	0,285	0,304
	ET-20060-200RJ	200	2.00	0,332	0,355
	ET-25060-200RJ	250	2.00	0,379	0,405
	ET-30060-200RJ	300	2.00	0,426	0,455
	ET-40060-200RJ	400	2.00	0,520	0,556
60	ET-50060-200RJ	500	2.00	0,615	0,657

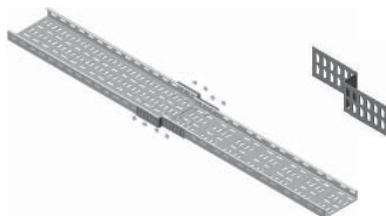

Universal Type Cable Trays

GENERAL CATALOGUE 2010

VT60 SERIES



Vertical Tees

Dikey T Bağlantı Elemanları



	Order Code Sipariş Kodu	Width Genişlik (mm)	Thickness Kalınlık (mm)	Weight* Ağırlık (Kg/Pcs)	Weight** Ağırlık (Kg/Pcs)
	ET-10060-150VT	105	1.50	1,558	1,691
1.50	ET-20060-150VT	205	1.50	2,517	2,731
	ET-30060-200VT	305	2.00	7,861	8,397
	ET-40060-200VT	405	2.00	12,323	13,163
	ET-50060-200VT	505	2.00	17,635	18,838
2.00	ET-60060-200VT	605	2.00	23,294	24,883

LC60 SERIES

Level Changing Parts

Seviye Değişirme Elemanları

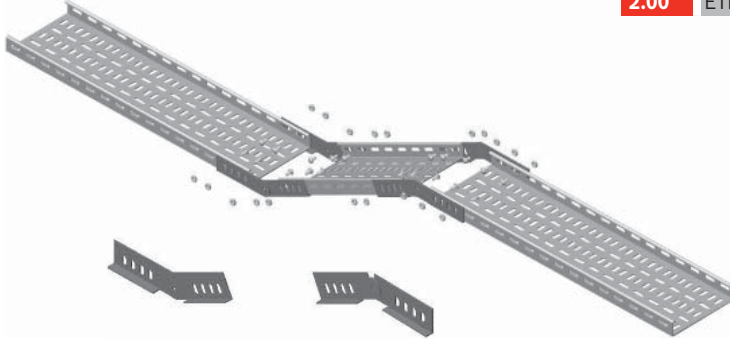

	Order Code Sipariş Kodu	Height Yükseklik (mm)	Thickness Kalınlık (mm)	Weight* Ağırlık (Kg/Set)	Weight** Ağırlık (Kg/Set)
2.00	ETLC-60-200	60	2.00	0,406	0,434

DC60 SERIES

Direction Changing Parts

Yön Değişirme Elemanları

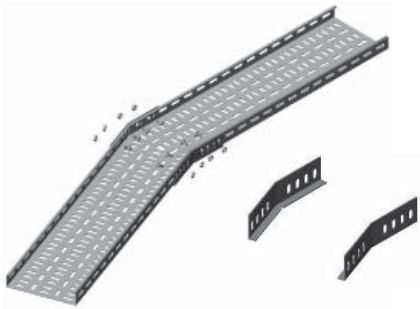

	Order Code Sipariş Kodu	Height Yükseklik (mm)	Thickness Kalınlık (mm)	Weight* Ağırlık (Kg/Pcs)	Weight** Ağırlık (Kg/Pcs)
2.00	ETDC-60-200	60	2.00	0,203	0,217

EP60 SERIES

End Parts

Sonlandırma Elemanları

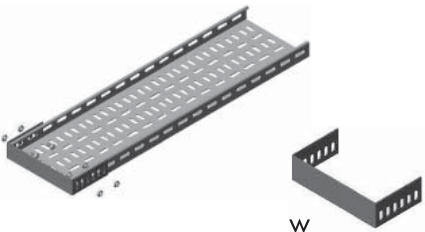

	Order Code Sipariş Kodu	Width Genişlik (mm)	Thickness Kalınlık (mm)	Weight* Ağırlık (Kg/Pcs)	Weight** Ağırlık (Kg/Pcs)
	ET-10060-150EP	105	1.50	0,203	0,220
1.50	ET-20060-150EP	205	1.50	0,273	0,297
	ET-30060-200EP	305	2.00	0,459	0,490
	ET-40060-200EP	405	2.00	0,553	0,591
	ET-50060-200EP	505	2.00	0,647	0,692
2.00	ET-60060-200EP	605	2.00	0,742	0,792

Universal Type Cable Trays

Üniversal Tip Kablo Kanalları

	Order Code Sipariş Kodu	Width Genişlik (mm)	Thickness Kalınlık (mm)	Weight* Ağırlık (Kg/m)	Weight** Ağırlık (Kg/m)
100	EU-100100-060	100	0.60	1,345	1,610
200	EU-200100-060	200	0.60	1,771	2,120
300	EU-300100-080	300	0.80	2,899	3,328
400	EU-400100-080	400	0.80	3,466	3,979
500	EU-500100-100	500	1.00	4,998	5,589
600	EU-600100-100	600	1.00	5,707	6,381

Weight* This weight is unit weight of Pregalvanized products.
Ağırlık* Pregalvaniz ürünlerin birim ağırlığıdır.

Weight** This weight is unit weight of Hot-dip galvanization coated products.
Ağırlık** Sıcak Daldırma Galvaniz kaplamalı ürünlerin birim ağırlığıdır.

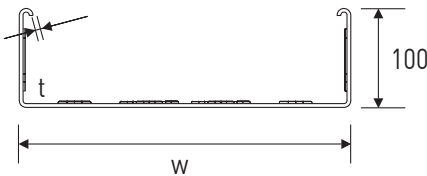
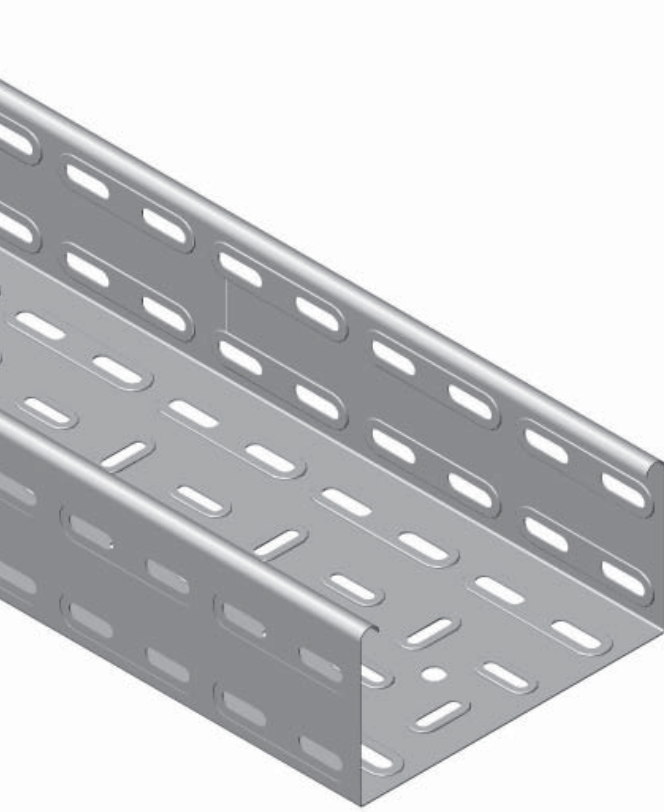

Description			
EU - 600 100 - 100			
Type	Width	Height	Thickness

Coating Type
P/HD/SP/E
Pregalvanized
Hot Dip Galvanized
Elektrostatic Paint
Elektro Galvanized

Length
2500/3000
mm

ETJ 100 SERIES

Joint Pieces

Bağlantı Elemanları

	Order Code Sipariş Kodu	Height Yükseklik (mm)	Thickness Kalınlık (mm)	Weight* Ağırlık (Kg/Pcs)	Weight** Ağırlık (Kg/Pcs)
	ETJ-100-150	100	1.50	0,228	0,247
100	ETJ-100-200	100	2.00	0,303	0,323

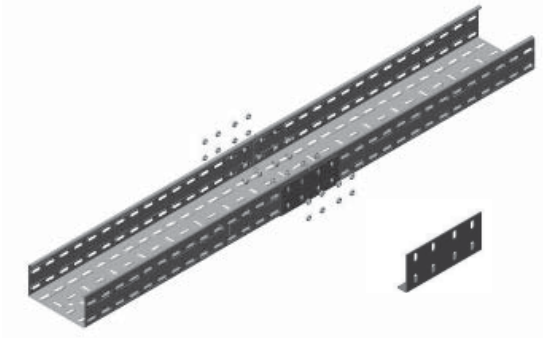

ETS 100 SERIES

Separators

Ayırıcı Separatörler

	Order Code Sipariş Kodu	Height Yükseklik (mm)	Thickness Kalınlık (mm)	Weight* Ağırlık (Kg/m)	Weight** Ağırlık (Kg/m)
	ETS-100-080	100	0.80	0,724	0,818
100	ETS-100-100	100	1.00	0,904	1,011

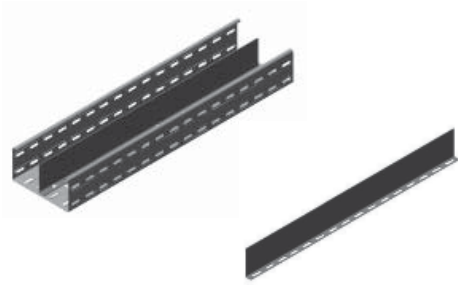

EU 100 SERIES

Loading Diagram

Yükleme Diyagramı

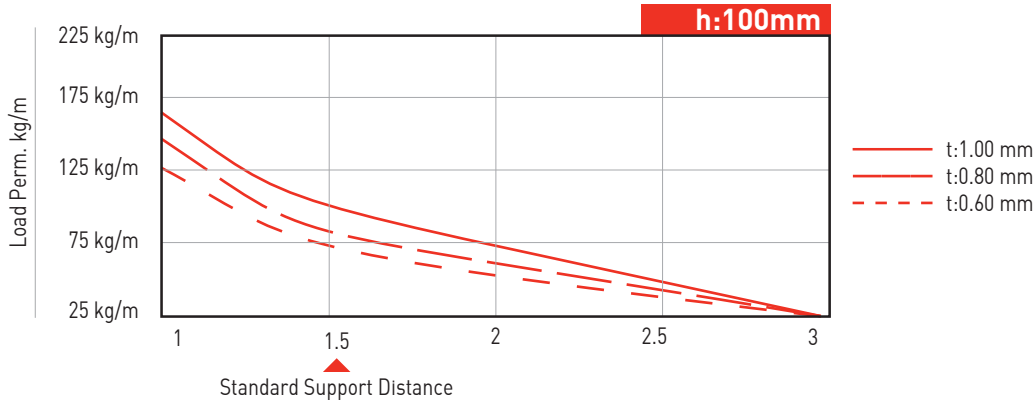

HB 100 SERIES



90° Horizontal Bends

90° Yatay Dönüş Elemanları (Standart)

	Order Code Sipariş Kodu	Width Genişlik (mm)	Thickness Kalınlık (mm)	Weight* Ağırlık (Kg/Pcs)	Weight** Ağırlık (Kg/Pcs)
	ET-100100-150HB	105	1.50	1,496	1,621
1.50	ET-200100-150HB	205	1.50	2,309	2,502
	ET-300100-200HB	305	2.00	3,833	4,136
	ET-400100-200HB	405	2.00	5,432	5,852
	ET-500100-200HB	505	2.00	7,345	7,904
2.00	ET-600100-200HB	605	2.00	9,572	10,291

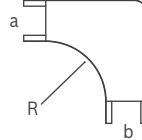
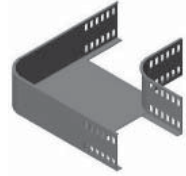

Please specify a, b dimensions in your private orders.
Özel siparişlerinizde a, b ölçülerini lütfen belirtiniz.

HT 100 SERIES



Horizontal Tees

T Bağlantı Elemanları (Standart)

	Order Code Sipariş Kodu	Width Genişlik (mm)	Thickness Kalınlık (mm)	Weight* Ağırlık (Kg/Pcs)	Weight** Ağırlık (Kg/Pcs)
	ET-100100-150HT	105	1.50	1,894	2,062
1.50	ET-200100-150HT	205	1.50	2,597	2,828
	ET-300100-200HT	305	2.00	4,076	4,395
	ET-400100-200HT	405	2.00	5,586	6,011
	ET-500100-200HT	505	2.00	7,409	7,963
2.00	ET-600100-200HT	605	2.00	9,546	10,250

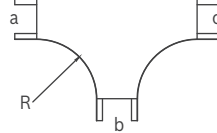

Please specify a, b, c dimensions in your private orders.
Özel siparişlerinizde a, b, c ölçülerini lütfen belirtiniz.

IR 100 SERIES



Adjustable Internal Risers

Ayarlanabilir İç Bükey Dönüş Elemanları

	Order Code Sipariş Kodu	Width Genişlik (mm)	Thickness Kalınlık (mm)	Weight* Ağırlık (Kg/Pcs)	Weight** Ağırlık (Kg/Pcs)
	EU-100100-060IR	100	0.60	1,177	1,409
0.60	EU-200100-060IR	200	0.60	1,603	1,919
	EU-300100-080IR	300	0.80	2,675	3,071
0.80	EU-400100-080IR	400	0.80	3,242	3,722
	EU-500100-100IR	500	1.00	4,718	5,275
1.00	EU-600100-100IR	600	1.00	5,427	6,068

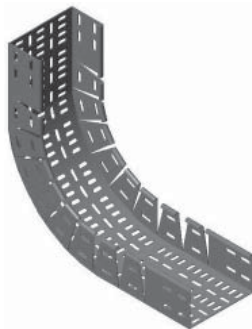

HB 100 SERIES



45° Horizontal Bends

45° Yatay Dönüş Elemanları (Standart)

	Order Code Sipariş Kodu	Width Genişlik (mm)	Thickness Kalınlık (mm)	Weight* Ağırlık (Kg/Pcs)	Weight** Ağırlık (Kg/Pcs)
	ET-100100-150HB45	105	1.50	1,065	1,153
1.50	ET-200100-150HB45	205	1.50	1,413	1,531
	ET-300100-200HB45	305	2.00	2,213	2,377
	ET-400100-200HB45	405	2.00	2,889	3,102
	ET-500100-200HB45	505	2.00	3,699	3,969
2.00	ET-600100-200HB45	605	2.00	4,638	4,974

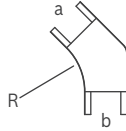

Please specify a, b dimensions in your private orders.
Özel siparişlerinizde a, b ölçülerini lütfen belirtiniz.

HC 100 SERIES



Horizontal Cross

Dörtlü Bağlantı Elemanları (Standart)

	Order Code Sipariş Kodu	Width Genişlik (mm)	Thickness Kalınlık (mm)	Weight* Ağırlık (Kg/Pcs)	Weight** Ağırlık (Kg/Pcs)
	ET-100100-150HC	105	1.50	2,251	2,438
1.50	ET-200100-150HC	205	1.50	2,845	3,081
	ET-300100-200HC	305	2.00	4,294	4,625
	ET-400100-200HC	405	2.00	5,713	6,142
	ET-500100-200HC	505	2.00	7,447	7,994
2.00	ET-600100-200HC	605	2.00	9,494	10,181

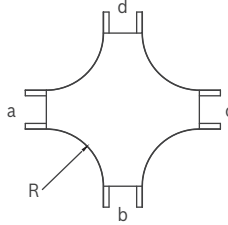

Please specify a, b, c, d dimensions in your private orders.
Özel siparişlerinizde a, b, c, d ölçülerini lütfen belirtiniz.

ER 100 SERIES



Adjustable External Risers

Ayarlanabilir Dış Bükey Dönüş Elemanları

	Order Code Sipariş Kodu	Width Genişlik (mm)	Thickness Kalınlık (mm)	Weight* Ağırlık (Kg/Pcs)	Weight** Ağırlık (Kg/Pcs)
	EU-100100-060ER	100	0.60	1,257	1,505
0.60	EU-200100-060ER	200	0.60	1,683	2,015
	EU-300100-080ER	300	0.80	2,782	3,194
0.80	EU-400100-080ER	400	0.80	3,349	3,844
	EU-500100-100ER	500	1.00	4,852	5,425
1.00	EU-600100-100ER	600	1.00	5,561	6,218

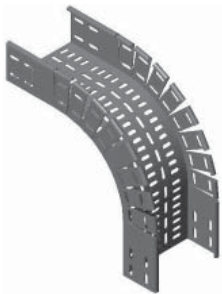

RC 100 SERIES



Reducers (Center)

Redüksiyonlar (Merkez)

	Order Code Sipariş Kodu	Width Genişlik (mm)	Thickness Kalınlık (mm)	Weight* Ağırlık (Kg/Pcs)	Weight** Ağırlık (Kg/Pcs)
1.50	ET-200100-150RC	205	1.50	1,810	1,961
	ET-300100-200RC	305	2.00	3,046	3,289
	ET-400100-200RC	405	2.00	4,405	4,749
	ET-500100-200RC	505	2.00	6,117	6,585
2.00	ET-600100-200RC	605	2.00	8,144	8,758

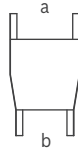
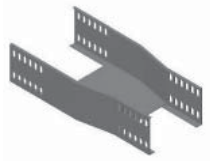

Please specify a, b dimensions in your private orders.
Özel siparişlerinizde a, b ölçülerini lütfen belirtiniz.

RR 100 SERIES



Reducers (Right)

Redüksiyonlar (Sağ)

	Order Code Sipariş Kodu	Width Genişlik (mm)	Thickness Kalınlık (mm)	Weight* Ağırlık (Kg/Pcs)	Weight** Ağırlık (Kg/Pcs)
1.50	ET-200100-150RR	205	1.50	1,787	1,936
	ET-300100-200RR	305	2.00	3,049	3,293
	ET-400100-200RR	405	2.00	4,421	4,766
	ET-500100-200RR	505	2.00	6,129	6,598
2.00	ET-600100-200RR	605	2.00	8,155	8,770



Please specify a, b dimensions in your private orders.
Özel siparişlerinizde a, b ölçülerini lütfen belirtiniz.

RL 100 SERIES



Reducers (Left)

Redüksiyonlar (Sol)

	Order Code Sipariş Kodu	Width Genişlik (mm)	Thickness Kalınlık (mm)	Weight* Ağırlık (Kg/Pcs)	Weight** Ağırlık (Kg/Pcs)
1.50	ET-200100-150RL	205	1.50	1,787	1,936
	ET-300100-200RL	305	2.00	3,049	3,293
	ET-400100-200RL	405	2.00	4,421	4,766
	ET-500100-200RL	505	2.00	6,129	6,598
2.00	ET-600100-200RL	605	2.00	8,155	8,770

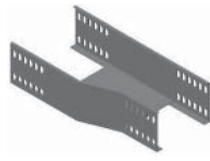

Please specify a, b dimensions in your private orders.
Özel siparişlerinizde a, b ölçülerini lütfen belirtiniz.

RJ 100 SERIES

Reducing Plate

Ek Parça Tipi Redüksiyon Elemanları

	Order Code Sipariş Kodu	Width Genişlik (mm)	Thickness Kalınlık (mm)	Weight* Ağırlık (Kg/Pcs)	Weight** Ağırlık (Kg/Pcs)
	ET-050100-200RJ	50	2.00	0,327	0,350
	ET-100100-200RJ	100	2.00	0,406	0,434
	ET-150100-200RJ	150	2.00	0,484	0,518
	ET-200100-200RJ	200	2.00	0,563	0,601
	ET-250100-200RJ	250	2.00	0,641	0,685
	ET-300100-200RJ	300	2.00	0,720	0,769
	ET-400100-200RJ	400	2.00	0,877	0,937
100	ET-500100-200RJ	500	2.00	1,034	1,105

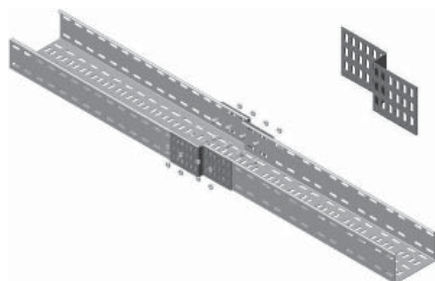

VT 100 SERIES



Vertical Tees

Dikey T Bağlantı Elemanları



	Order Code Sipariş Kodu	Width Genişlik (mm)	Thickness Kalınlık (mm)	Weight* Ağırlık (Kg/Pcs)	Weight** Ağırlık (Kg/Pcs)
	ET-100100-150VT	105	1.50	1,799	1,952
1.50	ET-200100-150VT	205	1.50	3,829	4,154
	ET-300100-200VT	305	2.00	8,538	9,121
	ET-400100-200VT	405	2.00	13,392	14,305
	ET-500100-200VT	505	2.00	18,669	19,942
2.00	ET-600100-200VT	605	2.00	24,505	26,177

LC 100 SERIES

Level Changing Parts

Seviye Değişirme Elemanları

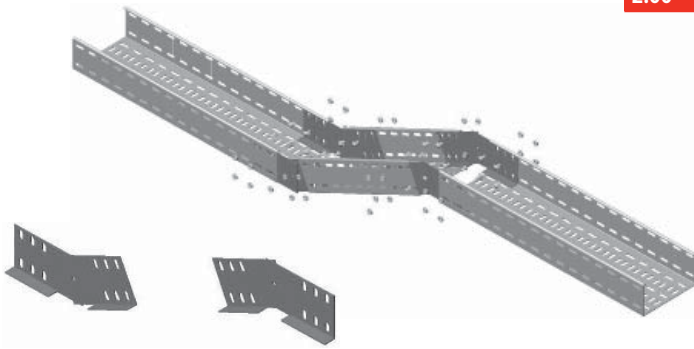

	Order Code Sipariş Kodu	Height Yükseklik (mm)	Thickness Kalınlık (mm)	Weight* Ağırlık (Kg/Set)	Weight** Ağırlık (Kg/Set)
2.00	ETLC-100-200	100	2.00	0,663	0,709

DC 100 SERIES

Direction Changing Parts

Yön Değişirme Elemanları

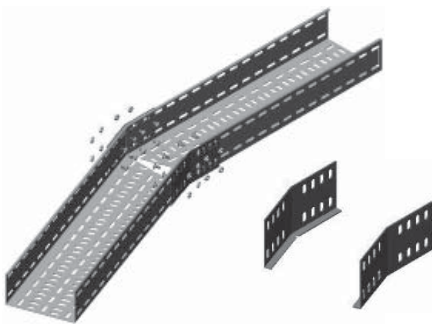

	Order Code Sipariş Kodu	Height Yükseklik (mm)	Thickness Kalınlık (mm)	Weight* Ağırlık (Kg/Pcs)	Weight** Ağırlık (Kg/Pcs)
2.00	ETDC-100-200	100	2.00	0,303	0,323

EP 100 SERIES

End Parts

Sonlandırma Elemanları

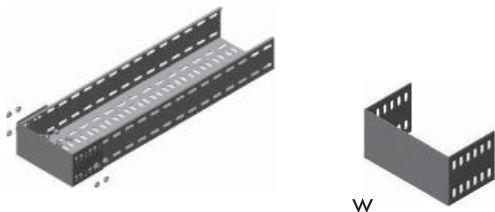

	Order Code Sipariş Kodu	Width Genişlik (mm)	Thickness Kalınlık (mm)	Weight* Ağırlık (Kg/Pcs)	Weight** Ağırlık (Kg/Pcs)
	ET-100100-150EP	105	1.50	0,330	0,359
1.50	ET-200100-150EP	205	1.50	0,448	0,486
	ET-300100-200EP	305	2.00	0,755	0,807
	ET-400100-200EP	405	2.00	0,912	0,974
	ET-500100-200EP	505	2.00	1,069	1,142
2.00	ET-600100-200EP	605	2.00	1,226	1,310