

Cover For Cable Ladders

Kablo Merdiveni Kapakları

	Order Code Sipariş Kodu	Width Genişlik (mm)	Thickness Kalınlık (mm)	Weight* Ağırlık (Kg/m)	Weight** Ağırlık (Kg/m)
	ELC-10015-080	105	0.80	0,816	0,936
	ELC-10015-100	105	1.00	1,020	1,140
	ELC-10015-120	105	1.20	1,224	1,354
	ELC-10015-150	105	1.50	1,529	1,659
100	ELC-10015-200	105	2.00	2,039	2,179
	ELC-15015-080	155	0.80	1,130	1,297
	ELC-15015-100	155	1.00	1,412	1,579
	ELC-15015-120	155	1.20	1,695	1,875
	ELC-15015-150	155	1.50	2,118	2,298
150	ELC-15015-200	155	2.00	2,824	3,017
	ELC-20015-080	205	0.80	1,444	1,657
	ELC-20015-100	205	1.00	1,805	2,018
	ELC-20015-120	205	1.20	2,166	2,396
	ELC-20015-150	205	1.50	2,707	2,937
200	ELC-20015-200	205	2.00	3,609	3,856
	ELC-25015-100	255	1.00	2,197	2,457
	ELC-25015-120	255	1.20	2,637	2,917
	ELC-25015-150	255	1.50	3,296	3,576
250	ELC-25015-200	255	2.00	4,394	4,694
	ELC-30015-100	305	1.00	2,590	2,896
	ELC-30015-120	305	1.20	3,108	3,438
	ELC-30015-150	305	1.50	3,884	4,214
300	ELC-30015-200	305	2.00	5,179	5,533
	ELC-40015-120	405	1.20	4,050	4,480
	ELC-40015-150	405	1.50	5,062	5,492
400	ELC-40015-200	405	2.00	6,749	7,210
	ELC-50015-120	505	1.20	4,992	5,522
	ELC-50015-150	505	1.50	6,239	6,769
500	ELC-50015-200	505	2.00	8,319	8,887
	ELC-60015-120	605	1.20	5,934	6,564
	ELC-60015-150	605	1.50	7,417	8,047
600	ELC-60015-200	605	2.00	9,889	10,564
	ELC-75015-150	755	1.50	9,183	9,963
750	ELC-75015-200	755	2.00	12,244	13,080
	ELC-90015-150	905	1.50	10,949	11,879
900	ELC-90015-200	905	2.00	14,599	15,595

Weight* This weight is unit weight of Pregalvanized products.

Weight** This weight is unit weight of Hot-dip galvanization coated products.

Ağırlık* Pregalvaniz ürünlerin birim ağırlığıdır.

Ağırlık** Sıcak Daldırma Galvaniz kaplamalı ürünlerin birim ağırlığıdır.

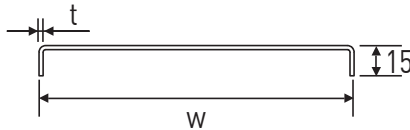

Description			
ELC	-600	15	-150
Type	Width	Height	Thickness

Coating Type
P/HD/SP/E
Pregalvanized
Hot Dip Galvanized
Elektrostatic Paint
Elektro Galvanized

Length
2500/3000
mm

ECCSERIES

Cover Clamp For Cable Ladders

Kapak Tutucu Elemanları

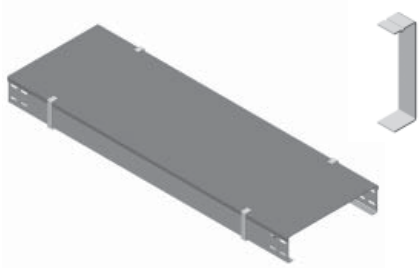

Order Code
Sipariş Kodu

Height
Yükseklik
(mm)

Thickness
Kalınlık
(mm)

Weight*
Ağırlık
(Kg/Pcs)

ECC-40-150	40	1.50	0,021
ECC-50-150	50	1.50	0,023
ECC-60-150	60	1.50	0,025
1.50 ECC-70-150	70	1.50	0,028
ECC-100-200	100	2.00	0,046
2.00 ECC-150-200	150	2.00	0,062

ECCSERIES

Cover Clamp For Bends

Dönüş Kapakları Tutucu Elemanları

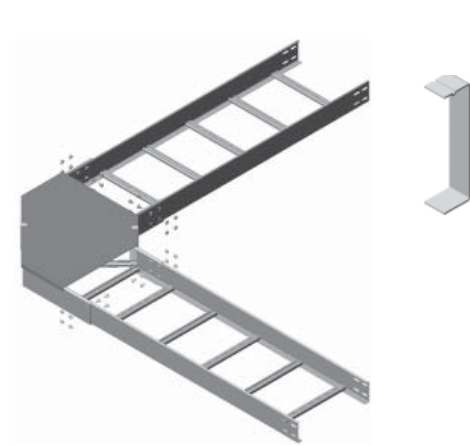

Order Code
Sipariş Kodu

Height
Yükseklik
(mm)

Thickness
Kalınlık
(mm)

Weight*
Ağırlık
(Kg/Pcs)

ECC-45-150	45	1.50	0,022
ECC-55-150	55	1.50	0,024
ECC-65-150	65	1.50	0,026
1.50 ECC-75-150	75	1.50	0,029
ECC-105-200	105	2.00	0,048
2.00 ECC-155-200	155	2.00	0,063

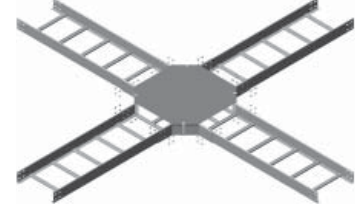
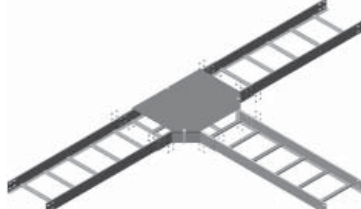

Cover For 90° Horizontal Bends

90° Yatay Dönüş Kapakları (Standart)



Order Code Sipariş Kodu	Width Genişlik (mm)	Thickness Kalınlık (mm)	Weight* Ağırlık (Kg/Pcs)	Weight** Ağırlık (Kg/Pcs)
ELC-10015-150HB	105	1.50	0,682	0,740
ELC-15015-150HB	155	1.50	0,958	1,039
ELC-20015-150HB	205	1.50	1,303	1,413
ELC-25015-150HB	255	1.50	1,698	1,842
ELC-30015-150HB	305	1.50	2,140	2,322
ELC-40015-150HB	405	1.50	3,170	3,439
ELC-50015-150HB	505	1.50	4,395	4,768
ELC-60015-150HB	605	1.50	5,815	6,309
ELC-75015-150HB	755	1.50	8,311	9,016
1.50 ELC-90015-150HB	905	1.50	11,246	12,201

Cover For Horizontal Tees

T Bağlantı Kapakları (Standart)



Order Code Sipariş Kodu	Width Genişlik (mm)	Thickness Kalınlık (mm)	Weight* Ağırlık (Kg/Pcs)	Weight** Ağırlık (Kg/Pcs)
ELC-10015-150HT	105	1.50	1,157	1,255
ELC-15015-150HT	155	1.50	1,589	1,724
ELC-20015-150HT	205	1.50	2,080	2,256
ELC-25015-150HT	255	1.50	2,630	2,853
ELC-30015-150HT	305	1.50	3,238	3,513
ELC-40015-150HT	405	1.50	4,632	5,026
ELC-50015-150HT	505	1.50	6,262	6,794
ELC-60015-150HT	605	1.50	8,127	8,818
ELC-75015-150HT	755	1.50	11,367	12,332
1.50 ELC-90015-150HT	905	1.50	15,136	16,421

Cover For Horizontal Cross

Dörtlü Bağlantı Kapakları (Standart)



Order Code Sipariş Kodu	Width Genişlik (mm)	Thickness Kalınlık (mm)	Weight* Ağırlık (Kg/Pcs)	Weight** Ağırlık (Kg/Pcs)
ETC-10015-150HC	105	1.50	1,609	1,745
ETC-15015-150HC	155	1.50	2,117	2,297
ETC-20015-150HC	205	1.50	2,685	2,913
ETC-25015-150HC	255	1.50	3,311	3,592
ETC-30015-150HC	305	1.50	3,996	4,336
ETC-40015-150HC	405	1.50	5,544	6,015
ETC-50015-150HC	505	1.50	7,326	7,949
ETC-60015-150HC	605	1.50	9,345	10,138
ETC-75015-150HC	755	1.50	12,814	13,902
1.50 ETC-90015-150HC	905	1.50	16,812	18,240

HB SERIES

Cover For 90° Horizontal Bends (R=300)

90° Yatay Dönüş Kapakları (R=300mm)



Order Code Sipariş Kodu	Width Genişlik (mm)	Thickness Kalınlık (mm)	Weight* Ağırlık (Kg/Pcs)	Weight** Ağırlık (Kg/Pcs)
ELC-10015-150HB/300R	105	1.50	1,353	1,468
ELC-15015-150HB/300R	155	1.50	1,794	1,947
ELC-20015-150HB/300R	205	1.50	2,284	2,478
ELC-25015-150HB/300R	255	1.50	2,824	3,064
ELC-30015-150HB/300R	305	1.50	3,412	3,702
ELC-40015-150HB/300R	405	1.50	4,735	5,138
ELC-50015-150HB/300R	505	1.50	6,252	6,783
ELC-60015-150HB/300R	605	1.50	7,958	8,633
ELC-75015-150HB/300R	755	1.50	11,054	11,993
1.50 ELC-90015-150HB/300R	905	1.50	14,603	15,843

HT SERIES

Cover For Horizontal Tees (R=300)

T Bağlantı Kapakları (R=300mm)



Order Code Sipariş Kodu	Width Genişlik (mm)	Thickness Kalınlık (mm)	Weight* Ağırlık (Kg/Pcs)	Weight** Ağırlık (Kg/Pcs)
ELC-10015-150HT/300R	105	1.50	2,693	2,921
ELC-15015-150HT/300R	155	1.50	3,390	3,678
ELC-20015-150HT/300R	205	1.50	4,146	4,498
ELC-25015-150HT/300R	255	1.50	4,961	5,382
ELC-30015-150HT/300R	305	1.50	5,834	6,330
ELC-40015-150HT/300R	405	1.50	7,758	8,417
ELC-50015-150HT/300R	505	1.50	9,918	10,760
ELC-60015-150HT/300R	605	1.50	12,313	13,359
ELC-75015-150HT/300R	755	1.50	16,347	17,735
1.50 ELC-90015-150HT/300R	905	1.50	20,911	22,687

HC SERIES

Cover For Horizontal Tees (R=300)

Dörtlü Bağlantı Kapakları (R=300mm)

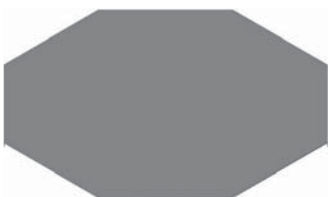

Order Code Sipariş Kodu	Width Genişlik (mm)	Thickness Kalınlık (mm)	Weight* Ağırlık (Kg/Pcs)	Weight** Ağırlık (Kg/Pcs)
ELC-10015-150HC/300R	105	1.50	4,162	4,515
ELC-15015-150HC/300R	155	1.50	5,024	5,450
ELC-20015-150HC/300R	205	1.50	5,944	6,449
ELC-25015-150HC/300R	255	1.50	6,924	7,512
ELC-30015-150HC/300R	305	1.50	7,963	8,639
ELC-40015-150HC/300R	405	1.50	10,216	11,084
ELC-50015-150HC/300R	505	1.50	12,706	13,785
ELC-60015-150HC/300R	605	1.50	15,430	16,741
ELC-75015-150HC/300R	755	1.50	19,959	21,654
1.50 ELC-90015-150HC/300R	905	1.50	25,018	27,142

Cover For 90° Horizontal Bends (R=600)

90° Yatay Dönüş Kapakları (R=600mm)



Order Code Sipariş Kodu	Width Genişlik (mm)	Thickness Kalınlık (mm)	Weight* Ağırlık (Kg/Pcs)	Weight** Ağırlık (Kg/Pcs)
ELC-10015-150HB/600R	105	1.50	3,250	3,526
ELC-15015-150HB/600R	155	1.50	3,984	4,322
ELC-20015-150HB/600R	205	1.50	4,768	5,173
ELC-25015-150HB/600R	255	1.50	5,603	6,079
ELC-30015-150HB/600R	305	1.50	6,494	7,045
ELC-40015-150HB/600R	405	1.50	8,435	9,152
ELC-50015-150HB/600R	505	1.50	10,774	11,689
ELC-60015-150HB/600R	605	1.50	13,336	14,468
ELC-75015-150HB/600R	755	1.50	17,716	19,220
1.50 ELC-90015-150HB/600R	905	1.50	22,616	24,537

Cover For Horizontal Tees (R=600)

T Bağlantı Kapakları (R=600mm)



Order Code Sipariş Kodu	Width Genişlik (mm)	Thickness Kalınlık (mm)	Weight* Ağırlık (Kg/Pcs)	Weight** Ağırlık (Kg/Pcs)
ELC-10015-150HT/600R	105	1.50	7,355	7,980
ELC-15015-150HT/600R	155	1.50	8,582	9,311
ELC-20015-150HT/600R	205	1.50	9,868	10,706
ELC-25015-150HT/600R	255	1.50	11,213	12,165
ELC-30015-150HT/600R	305	1.50	12,617	13,688
ELC-40015-150HT/600R	405	1.50	15,600	16,925
ELC-50015-150HT/600R	505	1.50	18,820	20,418
ELC-60015-150HT/600R	605	1.50	22,274	24,166
ELC-75015-150HT/600R	755	1.50	27,898	30,267
1.50 ELC-90015-150HT/600R	905	1.50	34,052	36,944

Cover For Horizontal Cross (R=600)

Dörtlü Bağlantı Kapakları (R=600mm)



Order Code Sipariş Kodu	Width Genişlik (mm)	Thickness Kalınlık (mm)	Weight* Ağırlık (Kg/Pcs)	Weight** Ağırlık (Kg/Pcs)
ELC-10015-150HC/600R	105	1.50	12,449	13,506
ELC-15015-150HC/600R	155	1.50	14,017	15,207
ELC-20015-150HC/600R	205	1.50	15,644	16,973
ELC-25015-150HC/600R	255	1.50	17,331	18,802
ELC-30015-150HC/600R	305	1.50	19,076	20,696
ELC-40015-150HC/600R	405	1.50	22,742	24,674
ELC-50015-150HC/600R	505	1.50	26,645	28,907
ELC-60015-150HC/600R	605	1.50	30,782	33,397
ELC-75015-150HC/600R	755	1.50	37,430	40,609
1.50 ELC-90015-150HC/600R	905	1.50	44,609	48,397

RC SERIES

Cover For Reducers (Center)

Redüksiyon Kapakları (Merkez)



Order Code Sipariş Kodu	Width Genişlik (mm)	Thickness Kalınlık (mm)	Weight* Ağırlık (Kg/Pcs)	Weight** Ağırlık (Kg/Pcs)
ELC-15015-150RC	155	1.50	0,229	0,248
ELC-20015-150RC	205	1.50	0,449	0,487
ELC-25015-150RC	255	1.50	0,715	0,776
ELC-30015-150RC	305	1.50	1,080	1,172
ELC-40015-150RC	405	1.50	1,848	2,005
ELC-50015-150RC	505	1.50	2,909	3,156
ELC-60015-150RC	605	1.50	4,207	4,564
ELC-75015-150RC	755	1.50	6,607	7,168
1.50 ELC-90015-150RC	905	1.50	9,533	10,342

RR SERIES

Cover For Reducers (Right)

Redüksiyon Kapakları (Sağ)



Order Code Sipariş Kodu	Width Genişlik (mm)	Thickness Kalınlık (mm)	Weight* Ağırlık (Kg/Pcs)	Weight** Ağırlık (Kg/Pcs)
ELC-15015-150RR	155	1.50	0,224	0,243
ELC-20015-150RR	205	1.50	0,444	0,482
ELC-25015-150RR	255	1.50	0,711	0,771
ELC-30015-150RR	305	1.50	1,077	1,168
ELC-40015-150RR	405	1.50	1,845	2,002
ELC-50015-150RR	505	1.50	2,906	3,152
ELC-60015-150RR	605	1.50	4,204	4,561
ELC-75015-150RR	755	1.50	6,604	7,165
1.50 ELC-90015-150RR	905	1.50	9,530	10,339

RL SERIES

Cover For Reducers (Left)

Redüksiyon Kapakları (Sol)



Order Code Sipariş Kodu	Width Genişlik (mm)	Thickness Kalınlık (mm)	Weight* Ağırlık (Kg/Pcs)	Weight** Ağırlık (Kg/Pcs)
ELC-15015-150RL	155	1.50	0,224	0,243
ELC-20015-150RL	205	1.50	0,444	0,482
ELC-25015-150RL	255	1.50	0,711	0,771
ELC-30015-150RL	305	1.50	1,077	1,168
ELC-40015-150RL	405	1.50	1,845	2,002
ELC-50015-150RL	505	1.50	2,906	3,152
ELC-60015-150RL	605	1.50	4,204	4,561
ELC-75015-150RL	755	1.50	6,604	7,165
1.50 ELC-90015-150RL	905	1.50	9,530	10,339

Cover For 45° Horizontal Bends

45° Yatay Dönüş Kapakları (Standart)



Order Code Sipariş Kodu	Width Genişlik (mm)	Thickness Kalınlık (mm)	Weight* Ağırlık (Kg/Pcs)	Weight** Ağırlık (Kg/Pcs)
ELC-10015-150HB45	105	1.50	0,267	0,289
ELC-15015-150HB45	155	1.50	0,457	0,496
ELC-20015-150HB45	205	1.50	0,660	0,716
ELC-25015-150HB45	255	1.50	1,020	1,107
ELC-30015-150HB45	305	1.50	1,322	1,434
ELC-40015-150HB45	405	1.50	1,920	2,083
ELC-50015-150HB45	505	1.50	2,757	2,991
ELC-60015-150HB45	605	1.50	3,732	4,049
ELC-75015-150HB45	755	1.50	5,567	6,040
1.50 ELC-90015-150HB45	905	1.50	7,657	8,307

Cover For 45° Horizontal Bends (R=300)

45° Yatay Dönüş Kapakları (R=300mm)



Order Code Sipariş Kodu	Width Genişlik (mm)	Thickness Kalınlık (mm)	Weight* Ağırlık (Kg/Pcs)	Weight** Ağırlık (Kg/Pcs)
ELC-10015-150HB45/300R	105	1.50	0,526	0,571
ELC-15015-150HB45/300R	155	1.50	0,615	0,667
ELC-20015-150HB45/300R	205	1.50	0,893	0,969
ELC-25015-150HB45/300R	255	1.50	1,201	1,303
ELC-30015-150HB45/300R	305	1.50	1,558	1,691
ELC-40015-150HB45/300R	405	1.50	2,429	2,636
ELC-50015-150HB45/300R	505	1.50	3,398	3,686
ELC-60015-150HB45/300R	605	1.50	4,521	4,904
ELC-75015-150HB45/300R	755	1.50	6,547	7,103
1.50 ELC-90015-150HB45/300R	905	1.50	8,915	9,672

Cover For 45° Horizontal Bends (R=600)

45° Yatay Dönüş Kapakları (R=600mm)



Order Code Sipariş Kodu	Width Genişlik (mm)	Thickness Kalınlık (mm)	Weight* Ağırlık (Kg/Pcs)	Weight** Ağırlık (Kg/Pcs)
ELC-10015-150HB45/600R	105	1.50	0,227	0,247
ELC-15015-150HB45/600R	155	1.50	0,748	0,811
ELC-20015-150HB45/600R	205	1.50	1,154	1,252
ELC-25015-150HB45/600R	255	1.50	1,597	1,733
ELC-30015-150HB45/600R	305	1.50	2,084	2,260
ELC-40015-150HB45/600R	405	1.50	3,251	3,527
ELC-50015-150HB45/600R	505	1.50	4,499	4,881
ELC-60015-150HB45/600R	605	1.50	6,003	6,513
ELC-75015-150HB45/600R	755	1.50	8,588	9,317
1.50 ELC-90015-150HB45/600R	905	1.50	11,552	12,533

IR SERIES

Cover For Adjustable Internal Risers

Ayarlanabilir İç Bükey Dönüş Kapakları

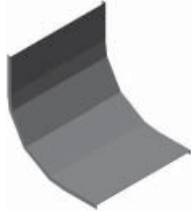

Order Code Sipariş Kodu	Width Genişlik (mm)	Thickness Kalınlık (mm)	Weight* Ağırlık (Kg/Pcs)	Weight** Ağırlık (Kg/Pcs)
ELC-10015-150IR	105	1.50	1,233	1,338
ELC-15015-150IR	155	1.50	1,695	1,839
ELC-20015-150IR	205	1.50	2,157	2,340
ELC-25015-150IR	255	1.50	2,619	2,842
ELC-30015-150IR	305	1.50	3,082	3,343
ELC-40015-150IR	405	1.50	4,006	4,346
ELC-50015-150IR	505	1.50	4,930	5,349
ELC-60015-150IR	605	1.50	5,855	6,352
ELC-75015-150IR	755	1.50	7,241	7,856
1.50 ELC-90015-150IR	905	1.50	8,628	9,360

ER SERIES

Cover For Adjustable External Risers

Ayarlanabilir Dış Bükey Dönüş Kapakları



Order Code Sipariş Kodu	Width Genişlik (mm)	Thickness Kalınlık (mm)	Weight* Ağırlık (Kg/Pcs)	Weight** Ağırlık (Kg/Pcs)
ELC-10015-150ER	105	1.50	1,343	1,457
ELC-15015-150ER	155	1.50	1,849	2,006
ELC-20015-150ER	205	1.50	2,356	2,556
ELC-25015-150ER	255	1.50	2,862	3,105
ELC-30015-150ER	305	1.50	3,368	3,654
ELC-40015-150ER	405	1.50	4,381	4,753
ELC-50015-150ER	505	1.50	5,394	5,852
ELC-60015-150ER	605	1.50	6,406	6,950
ELC-75015-150ER	755	1.50	7,925	8,598
1.50 ELC-90015-150ER	905	1.50	9,444	10,246

IR SERIES

Cover For 45° Internal Risers

45° İç Bükey Dönüş Kapakları

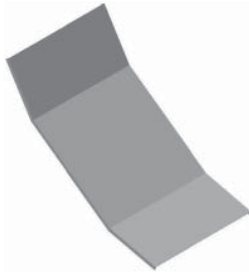

Order Code Sipariş Kodu	Width Genişlik (mm)	Thickness Kalınlık (mm)	Weight* Ağırlık (Kg/Pcs)	Weight** Ağırlık (Kg/Pcs)
ELC-10015-150IR45	105	1.50	0,856	0,929
ELC-15015-150IR45	155	1.50	1,177	1,277
ELC-20015-150IR45	205	1.50	1,498	1,625
ELC-25015-150IR45	255	1.50	1,819	1,973
ELC-30015-150IR45	305	1.50	2,140	2,322
ELC-40015-150IR45	405	1.50	2,782	3,018
ELC-50015-150IR45	505	1.50	3,423	3,714
ELC-60015-150IR45	605	1.50	4,065	4,410
ELC-75015-150IR45	755	1.50	5,028	5,455
1.50 ELC-90015-150IR45	905	1.50	5,990	6,499

ER SERIES

Cover For 45° External Risers

45° Dış Bükey Dönüş Kapakları



Order Code Sipariş Kodu	Width Genişlik (mm)	Thickness Kalınlık (mm)	Weight* Ağırlık (Kg/Pcs)	Weight** Ağırlık (Kg/Pcs)
ELC-10015-150ER45	105	1.50	0,905	0,982
ELC-15015-150ER45	155	1.50	1,246	1,352
ELC-20015-150ER45	205	1.50	1,588	1,723
ELC-25015-150ER45	255	1.50	1,929	2,093
ELC-30015-150ER45	305	1.50	2,271	2,464
ELC-40015-150ER45	405	1.50	2,954	3,205
ELC-50015-150ER45	505	1.50	3,637	3,946
ELC-60015-150ER45	605	1.50	4,320	4,687
ELC-75015-150ER45	755	1.50	5,344	5,798
1.50 ELC-90015-150ER45	905	1.50	6,369	6,909